

ELECTRICAL GRIPPER FEED EZ KV 040

Models: EZ KVC 040 | EZ KVD 040 | EZ KVE 040

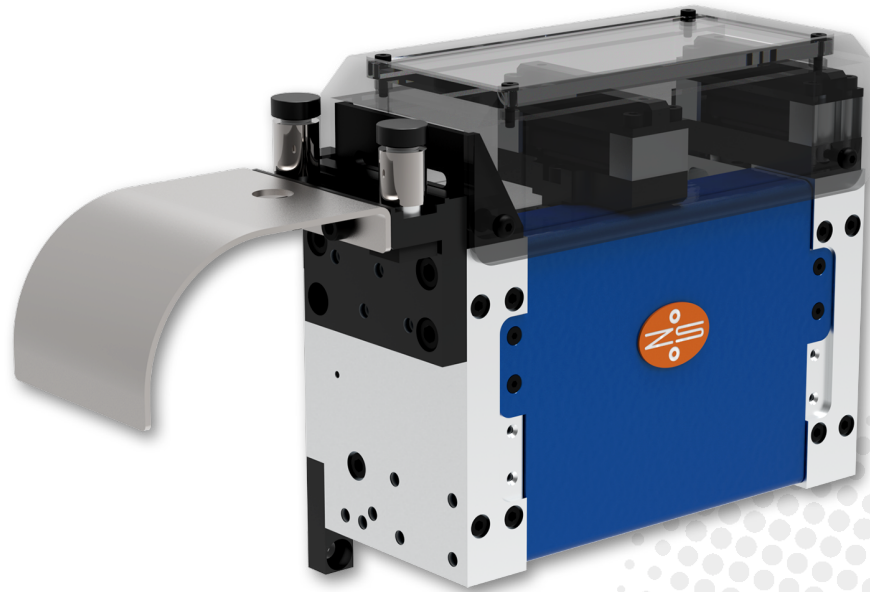

ACCURATE

- Precision mechanics and high-tech materials for highest accuracy
- Compact precision linear motor

VERSATILE INSTALLATION

- Compact vertical design with minimal installation width
- Available in 3 unit lengths: Compact (C), Double (D), Extended (E)
- Cable Connector Box: separate or on device (KVC)
- Variable infeeds: basket with double rolls, inlet plate, wire inlet

VERSATILE USE

- Prepared for additional clamps, better wire guiding, considerable clamping force
- Various tailor made clamping, gripping and guiding options
- Good visibility into gripper chamber for easy threading
- Threading help button (material insertion without operating the control)
- Adaptable roll basket to fit material properties

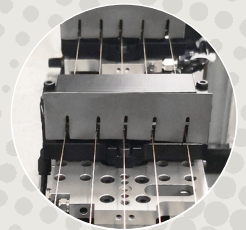
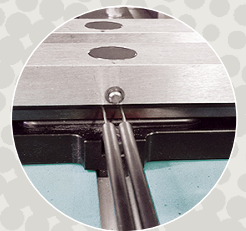

ELECTRICAL GRIPPER FEED EZ KV 040



PERFORMANCE

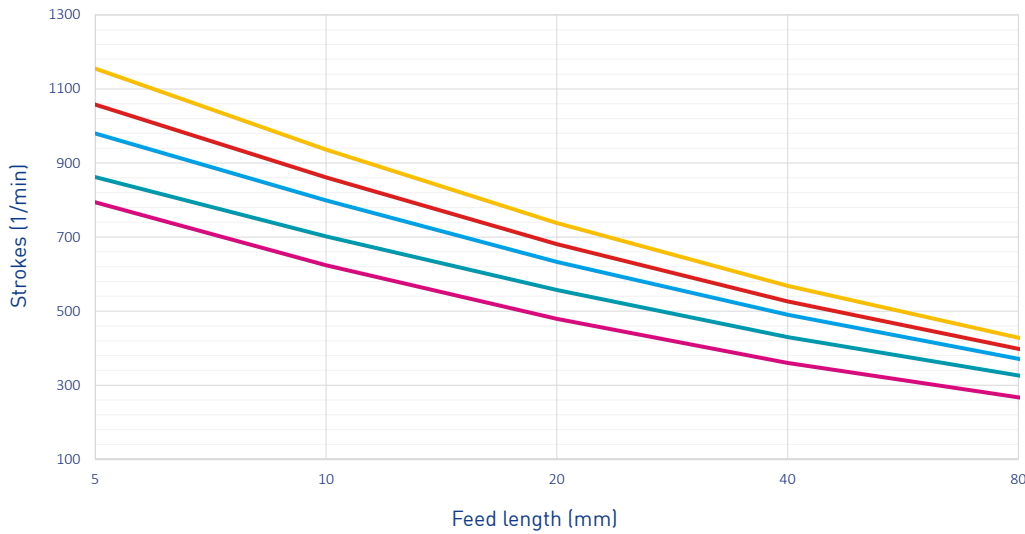

Performance curves (examples)*

Loop weight / Number of moving clamps

0 kg / 1 clamp

0.5 kg / 1 clamp

2 kg / 1 clamp

0.5 kg / 2 clamp

2 kg / 2 clamp

*Calculation basis: EZ KV-D 040
Optimum opening angle

TECHNICAL SPECIFICATIONS

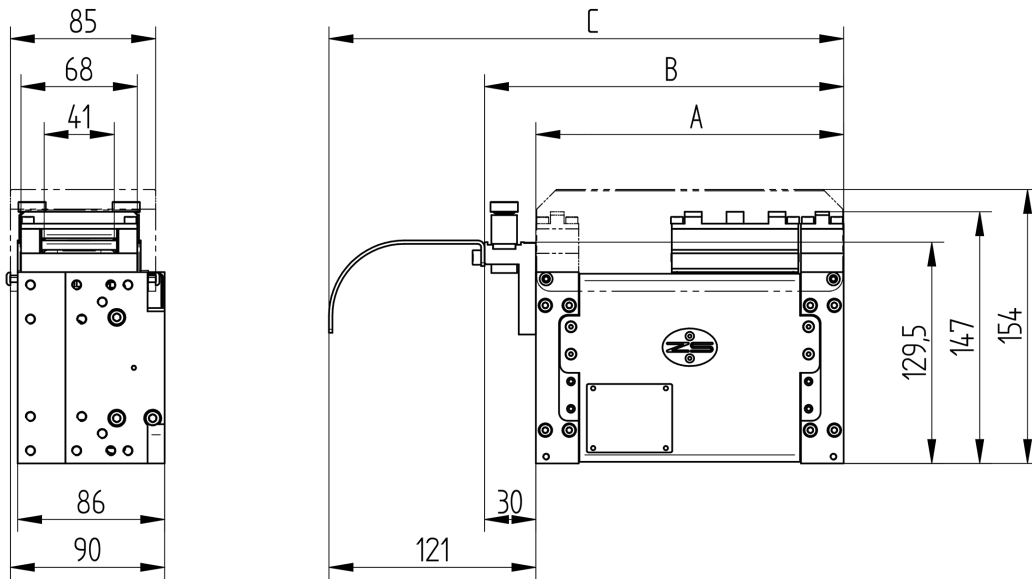

MODEL	EZ	KV-C 040	KV-D 040	KV-E 040
Bandwidth max. (mm)		40		
Feed length max. (mm)		50	102	152
A: Length basic unit (mm)		180	310	440
B: Length with inlet plate (mm)		210	340	470
C: Length with inlet metal sheet (mm)		311	441	571
Clamp opening		ca. 1 mm		
Accuracy (mm)		+/- 0,02	+/- 0,01	+/- 0,02
Nominal traction force (N)		60	65	68
Peak traction force, approx. (N)		100	140	150
Clamping force at 6 bar (movable gripper)		(1) 135 N / (2) 270 N		
Cross section (recommended)		max. 50 mm ²		

SWITZERLAND

Zehnder & Sommer AG
CH-3400 Burgdorf
info@zehndersommer.com
Tel +41 31 800 00 00

GERMANY

Zehnder & Sommer GmbH
DE-58452 Witten
info@zehndersommer.de
Tel +49 2302 981 60 30

zehndersommer.com
ZSswiss.com